

Focus 20W

FOCUS 20W 4000K 36° Black Ø60mm

Cod: **MTK0120**



IP20
Protected from solid bodies larger than 12 mm



II
Protection class II



CRI >90
Colour rendering index >90



ReeR warranty
ReeR guarantees the product for a time duration of 3 years



Technical description

Product code: MTK0120 | Category: Indoor luminaires | Model: Focus 20W | Product description: FOCUS 20W 4000K 36° Black Ø60mm | Source type: COB | Color temperature (CCT): 4000K | Color render index (CRI): > 90 | MacAdam (SDCM): < 4 | Lumen output (lm): 1800 | Beam angle: 36° | Photobiological risk: RG1 (low risk) | LED Lifetime: 30.000 h | Diameter (mm): 60 | Height (mm): 228 | Weight (g): 400 | IP rating: IP 20 | Finishing colour: Black RAL9017 | Type of finishing: Polyester powder coated | Body material: Die-cast aluminum | Diffuser material: PMMA (polymethyl methacrylate) | Maximal working temperature: -25° C | Minimal working temperature: +55° C | Nominal power (W): 20 | Power factor: > 0.9 | Power supply: 220/240V 50/60Hz | Ballast: Integrated | Insulation class: II | Dimmable: No |

Lighting data

Source type	COB	Beam angle	36°
Color temperature (CCT)	4000K	Photobiological risk	RG1 (low risk)
Color render index (CRI)	> 90	LED Lifetime	30.000 h
MacAdam (SDCM)	< 4		
Lumen output (lm)	1800		

Mechanical data

Diameter (mm)	60	Finishing colour	Black RAL9017
Height (mm)	228	Type of finishing	Polyester powder coated
Weight (g)	400	Body material	Die-cast aluminum
IP rating	IP 20	Diffuser material	PMMA (polymethyl methacrylate)

Electrical data

Nominal power (W)	20	Insulation class	II
Power factor	> 0.9	Dimmable	No
Power supply	220/240V 50/60Hz		
Ballast	Integrated		

Photometry

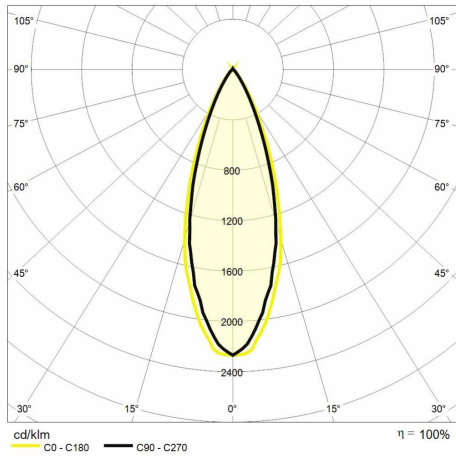

Technical drawing

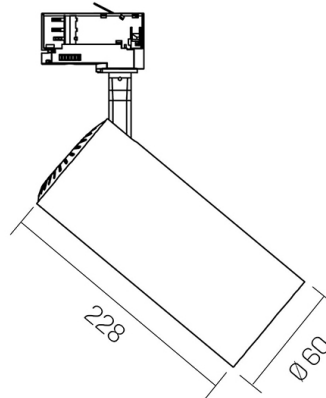

Accessories

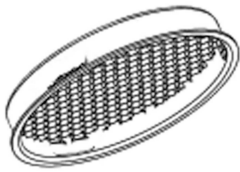

Focus 20W accessories

HONEYCOMB FOCUS 20W Ø60mm
black
Cod: MTK0137

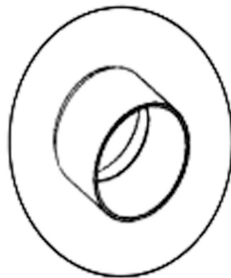

Focus 20W accessories

FOCUS JOINT 20W Ø60mm black
Cod: MTK0139



Focus 20W accessories

HONEYCOMB JOINT FOCUS 20W
Ø60mm black
Cod: MTK0141



Focus 20W accessories

OVAL JOINT FOCUS 20W Ø60mm black
Cod: MTK0143