

LED panel 600x600

PANEL LED 595x595mm 40W 230V IP20
UGR19 4000K

Cod: **6360748**



IP20
Protected from solid bodies larger than 12 mm



II
Protection class II



CRI >80
Colour rendering index >80



UGR <19
Meets the parameters of the UNI EN 12464-1 standard on workplace lighting



ReeR warranty
ReeR guarantees the product for a time duration of 3 years



Technical description

Product code: 6360748 | Category: Indoor luminaires | Model: LED panel 600x600 | Product description: PANEL LED 595x595mm 40W 230V IP20 UGR19 4000K | Source type: SMD 4014 | Number of LEDs: 204 | Color temperature (CCT): 4000K | Color render index (CRI): > 80 | MacAdam (SDCM): < 6 | Lumen output (lm): 3400 | Beam angle: 88° | Photobiological risk: RG0 (exempt) | LED Lifetime: 40.000 h | Energy efficiency class: This contains a light source of energy efficiency class (EU2019/2015): F | Width (mm): 591 | Length (mm): 591 | Height (mm): 9,8 | Weight (g): 2500 | IP rating: IP 20 | Finishing colour: White RAL9003 | Body material: Aluminum | Diffuser material: PS (polystyrene) | Maximal working temperature: -5° C | Minimal working temperature: +40° C | Nominal power (W): 40 | Power factor: > 0,9 | Power supply: 230V 50/60Hz | Ballast: Included | Insulation class: II | Dimmable: No |

Lighting data

Source type	SMD 4014	Beam angle	88°
Number of LEDs	204	Photobiological risk	RG0 (exempt)
Color temperature (CCT)	4000K	LED Lifetime	40.000 h
Color render index (CRI)	> 80	Energy efficiency class	This contains a light source of energy efficiency class (EU2019/2015): F
MacAdam (SDCM)	< 6		
Lumen output (lm)	3400		

Mechanical data

Width (mm)	591	IP rating	IP 20
Length (mm)	591	Finishing colour	White RAL9003
Height (mm)	98	Body material	Aluminum
Weight (g)	2500	Diffuser material	PS (polystyrene)

Electrical data

Nominal power (W)	40	Insulation class	II
Power factor	0,9	Dimmable	No
Power supply	230V 50/60Hz		
Ballast	Included		

Photometry

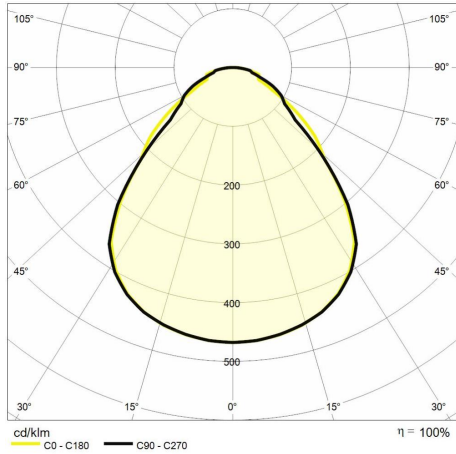

Technical drawing

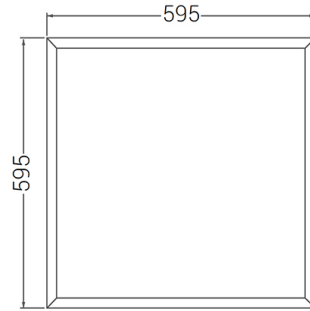

Accessories



Backlit and LED panel mounting kit

SUSPENSION KIT for PANEL code
6360411
Cod: 6360412

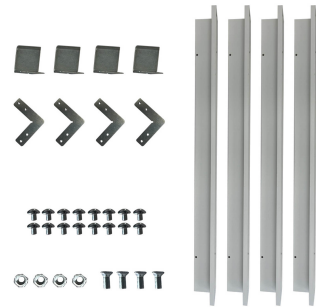

Backlit and LED panel mounting kit

CONTINUOUS MODULE FALSE CEILING
MOUNTING KIT
Cod: 6360507



Backlit and LED panel mounting kit

CEILING MOUNTING KIT for PANEL code
6360744/6360748
Cod: 6360745

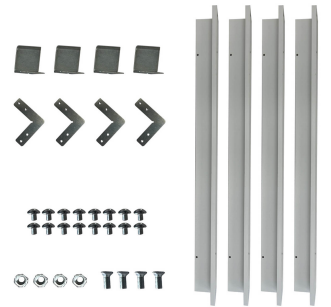

Backlit and LED panel mounting kit

CONTINUOUS MODULE FLUSH
MOUNTING BRACKET KIT
Cod: 6360747

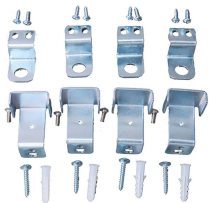

Backlit and LED panel mounting kit

CEILING MOUNTING BRACKET KIT

Cod: 6360764